

BRECHKUPPLUNG

Typ: HO 0303 Flanschbuchseinteil

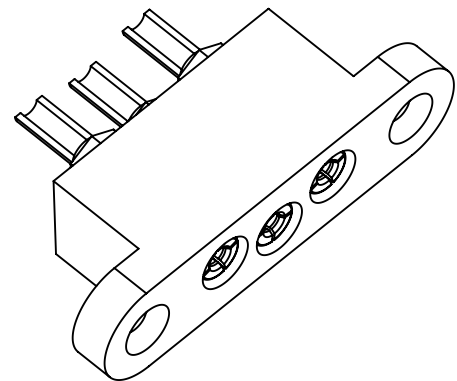
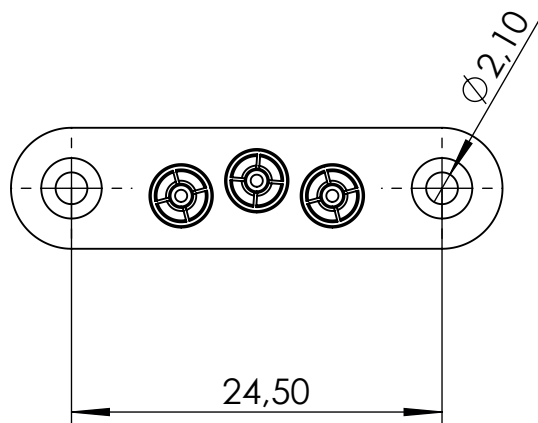
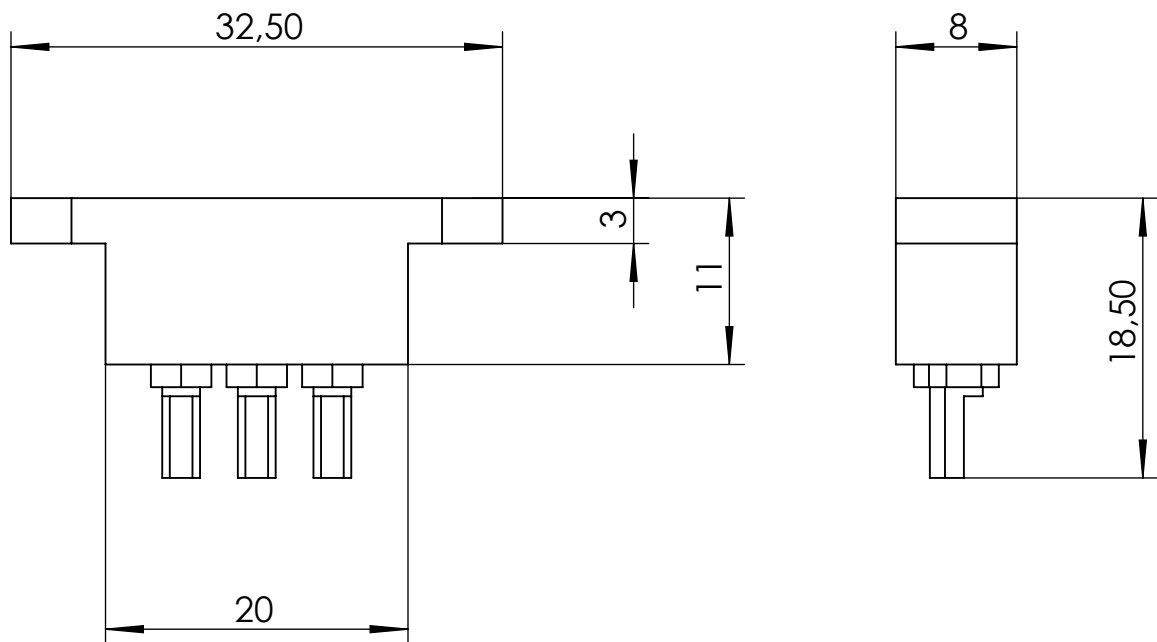

BRECHKUPPLUNG

Typ: HO 0303 Flanschbuchseenteil

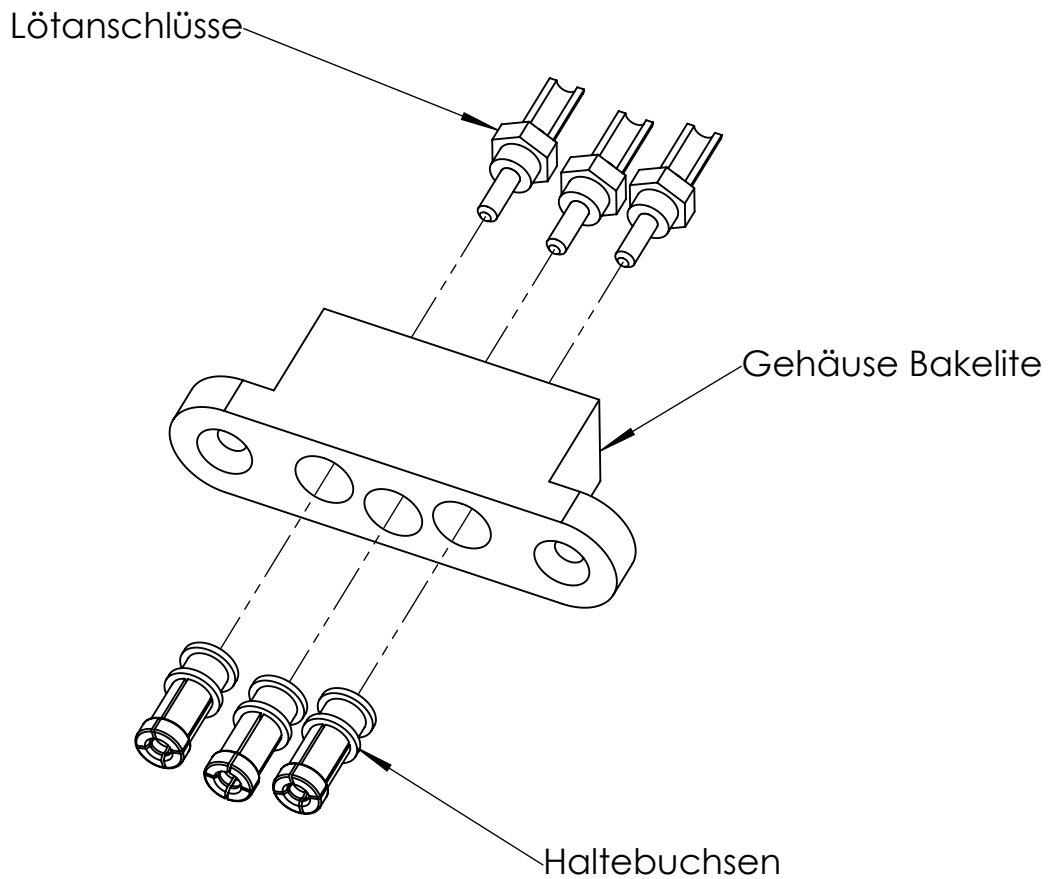

TECHNISCHE DATEN

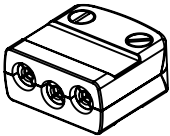
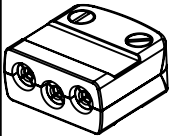
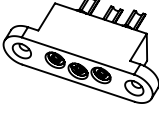
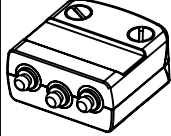
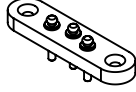
| Steckverbinder Gruppe | HO 0300 | | | | |
|-------------------------------------|---|---|--|---|---|
| Anzahl Pole | 3 | | | | |
| | Buchsentteile | | | Steckerteile | |
| Bezeichnung | HO 0301, sw | HO 0301, grau | HO 0303 | HO 0302 | HO 0304 |
| |  |  |  |  |  |
| Verwendung | Kabel | | Einbau | Kabel | Einbau |
| Artikelnummer | B 3016 | B 3103 | B 3018 | B 3017 | B 3019 |
| Material Kontakt- / Haltebuchsen | CuZn39Pb3 (versilbert) | | | - | |
| Material Steckerstifte | - | | | CuZn39Pb3 (vernickelt) | |
| Material Gehäuse | PA 6 schwarz | PA 6 grau | PA 6 schwarz | | |
| Kabelaußendurchmesser | 4 mm | | - | 4 mm | - |
| Anschlußquerschnitt | max. 0,8 mm ² | | max. 1,6 mm ² | | max. 0,25 mm ² |
| Betriebsspannung (nach VDE 0110) | 75V AC 60V DC | | | | |
| Durchgangswiderstand | < 1 mΩ | | | | |
| Dauerstrom | 4 A | | | | |
| Betriebstemperaturbereich | -25°C bis + 80°C | | | | |
| Sonstiges | Verpolungsschutz | | | | |