

BRECHKUPPLUNG

Typ: MO 0604 Flanschsteckerteil

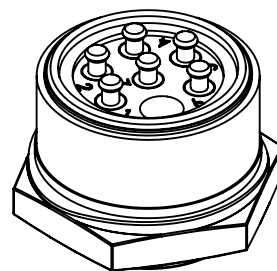

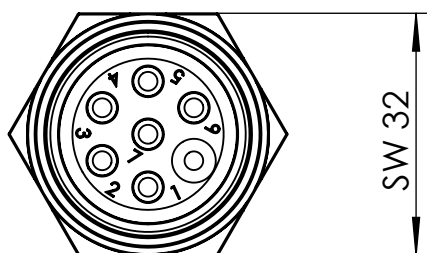
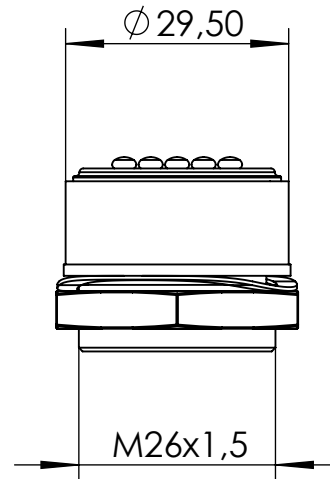
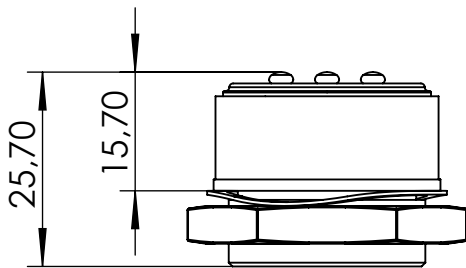

BRECHKUPPLUNG

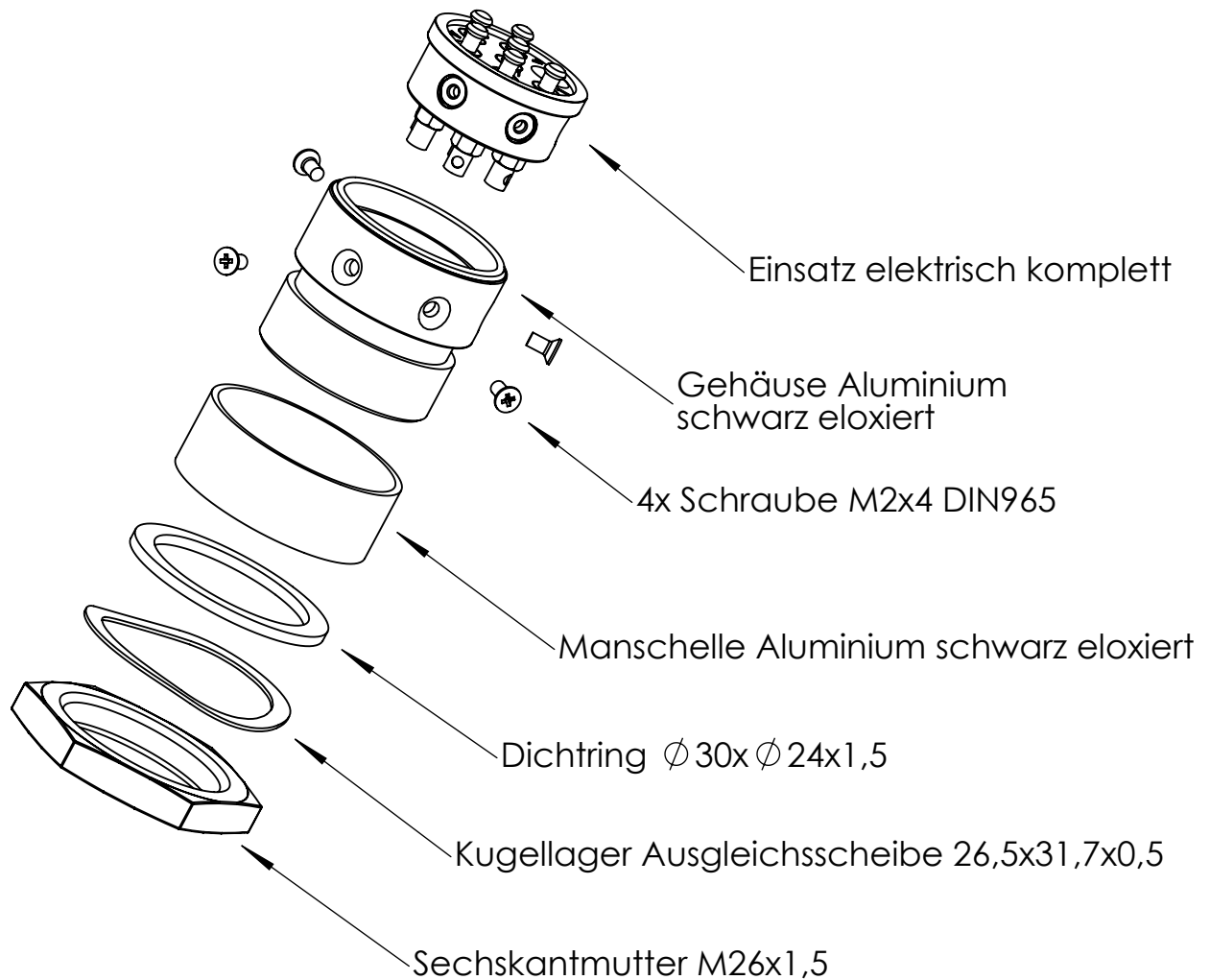
Typ: MO 0604 Flanschsteckerteil



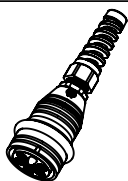
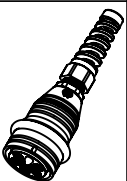
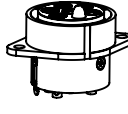
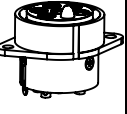
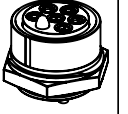





TECHNISCHE DATEN

Steckverbinder Gruppe	MO 0600					
Anzahl Pole	6					
	Buchsentteile					
Bezeichnung	MO 0601	MO 0601 G	MO 0603 C	MO 0603 CG	MO 0603 V	MO 0603 VG
						
Verwendung	Kabel		Einbau			
Artikelnummer	B 3001	B 3068	B 3110	B 3111	B 3003V	B 3109
Material Kontakt- / Haltebuchsen	CuZn39Pb3 (versilbert)	CuZn39Pb3 (vergoldet)	CuZn39Pb3 (versilbert)	CuZn39Pb3 (vergoldet)	CuZn39Pb3 (versilbert)	CuZn39Pb3 (vergoldet)
Material Gehäuse	AlMgSi1 (schwarz eloxiert)					
Material Isoliereinsatz	Bakelite PF 31.5 (schwarz)					
Material Lötanschlüsse	CuZn39Pb3 (versilbert)					
Material Kabelverschraubung	Polyamid (schwarz)					
Kabelaußendurchmesser	3,5 - 7,0 mm *		-		3,5 - 7,0 mm *	
Anschlußquerschnitt	max. 4,5 mm ²					
Betriebsspannung (nach VDE 0110)	75V AC 60V DC					
Durchgangswiderstand	< 1 mΩ	< 0,6 mΩ	< 1 mΩ	< 0,6 mΩ	< 1 mΩ	< 0,6 mΩ
Dauerstrom	10 A					
Betriebstemperaturbereich	-25°C bis +80°C					
Sonstiges	Verpolungsschutz Kabelverschraubung mit Zugentlastung + Biegeschutz (MO 0601, MO 0601 G)					

* auf Anfrage 1,0 - 5,0 mm

TECHNISCHE DATEN

Steckverbinder Gruppe	MO 0600					
Anzahl Pole	6					
	Steckerteile					
Bezeichnung	MO 0602	MO 0602 G	MO 0604	MO 0604 G	MO 0606	MO 0606 G
						
Verwendung	Kabel		Einbau		Kabel (Winkelstecker)	
Artikelnummer	B 3381	B 3070	B 3004	B 3112	B 3067	B 3113
Material Steckerstifte	CuZn39Pb3 (vernickelt)	CuZn39Pb3 (vergoldet)	CuZn39Pb3 (vernickelt)	CuZn39Pb3 (vergoldet)	CuZn39Pb3 (vernickelt)	CuZn39Pb3 (vergoldet)
Material Gehäuse	AlMgSi1 (schwarz eloxiert)					
Material Isoliereinsatz	Bakelite PF 31.5 (schwarz)					
Material Lötanschlüsse	CuZn39Pb3 (versilbert)					
Material Kabelerschraubung	Polyamid (schwarz)					
Kabelaußendurchmesser	3,5 - 7,0 mm *		-		3,5 - 7,0 mm *	
Anschlußquerschnitt	max. 4,5 mm ²					
Betriebsspannung (nach VDE 0110)	75V AC 60V DC					
Durchgangswiderstand	< 1 mΩ	< 0,6 mΩ	< 1 mΩ	< 0,6 mΩ	< 1 mΩ	< 0,6 mΩ
Dauerstrom	10 A					
Betriebstemperaturbereich	-25°C bis +80°C					
Sonstiges	Verpolungsschutz Kabelerschraubung mit Zugentlastung + Biegeschutz (MO 0602 (G), MO 0606 (G))					

* auf Anfrage 1,0 - 5,0 mm